

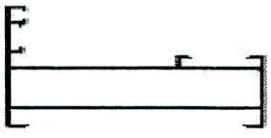









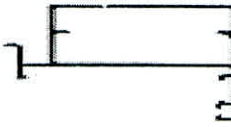
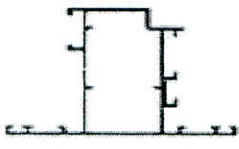
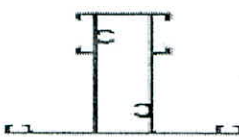

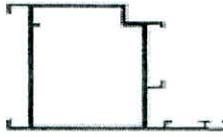
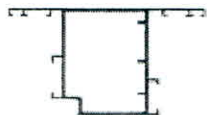
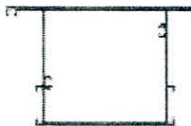

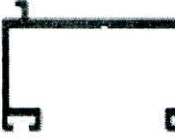

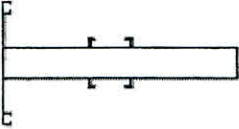
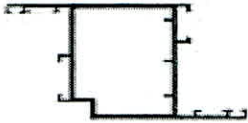

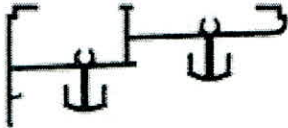

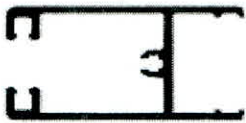
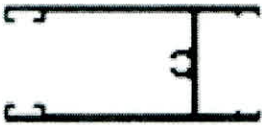
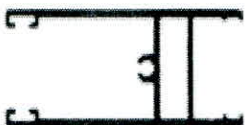
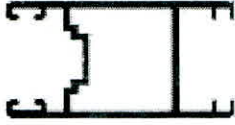
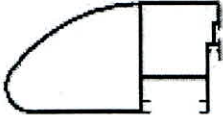
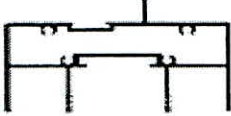
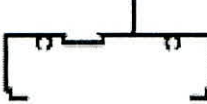

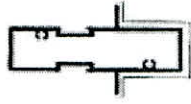

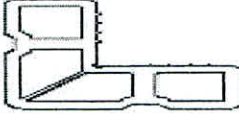
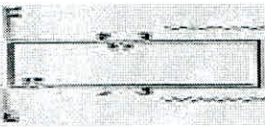
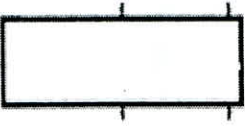
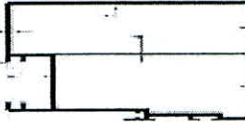
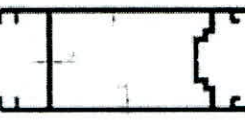
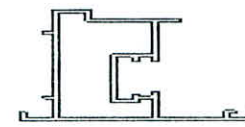
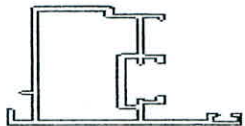
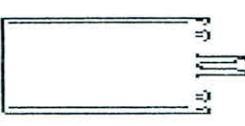

**Phụ lục 13 - Danh mục sản phẩm hợp kim nhôm dạng profile
 được cấp chứng nhận phù hợp quy chuẩn QCVN 16:2017/BXD
 (Ban hành kèm theo giấy chứng nhận số 44-16 (LIXIL 01-2018), ngày 31/07/2018)**

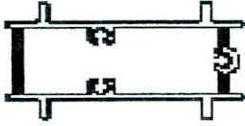
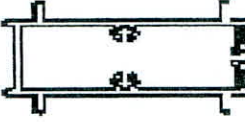
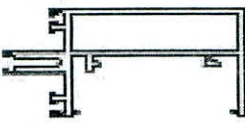

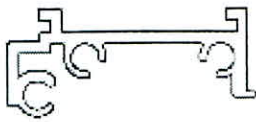
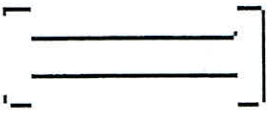

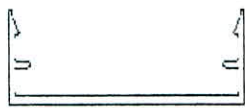

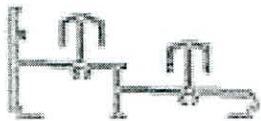

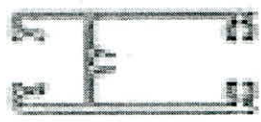
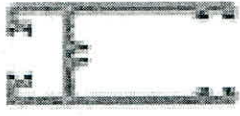
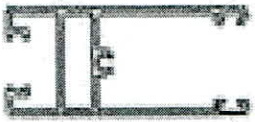
STT	Mã bản vẽ	Mặt cắt sản phẩm	Hợp kim - cấp độ cứng
1	TO-5J187		6063-TE
2	TO-5J188		6063-TE
3	TO-5J189		6063-TE
4	TO-5J190		6063-TE
5	TO-5J191		6063-TE
6	TO-5J192		6063-TE
7	TO-5J193		6063-TE
8	TO-5J194		6063-TE
9	TO-5J195		6063-TE
10	TO-5J196		6063-TE
11	TO-5J197		6063-TE

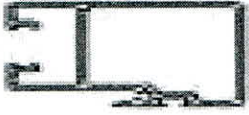
STT	Mã bản vẽ	Mặt cắt sản phẩm	Hợp kim - cấp độ cứng
12	TO-5J198		6063-TE
13	TO-5J199		6063-TE
14	TO-5J234		6063-TE
15	TO-5L854		6063-TE
16	TO-5J200		6063-TE
17	TO-5J201		6063-TE
18	TO-5J202		6063-TE
19	TO-5J203		6063-TE
20	TO-5J204		6063-TE
21	TO-5J205		6063-TE
22	TO-5J206		6063-TE

STT	Mã bản vẽ	Mặt cắt sản phẩm	Hợp kim - cấp độ cứng
23	TO-5J207		6063-TE
24	TO-5J208		6063-TE
25	TO-5J209		6063-TE
26	TO-5J210		6063-TE
27	TO-5J211		6063-TE
28	TO-5J229		6063-TE
29	TO-5J233		6063-TE
30	TO-5J230		6063-TE
31	TO-5J231		6063-TE
32	TO-5J232		6063-TE
33	TO-5L871		6063-TE

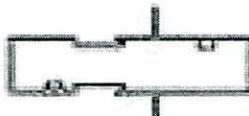

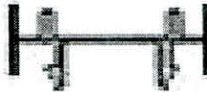
STT	Mã bản vẽ	Mặt cắt sản phẩm	Hợp kim - cấp độ cứng
34	TO-5L872		6063-TE
35	TO-5L873		6063-TE
36	TO-5L874		6063-TE
37	TO-5L875		6063-TE
38	TO-5L883		6063-TE
39	TO-5L884		6063-TE
40	TO-5L861		6063-TE
41	TO-5L862		6063-TE
42	TO-5L869		6063-TE
43	TO-5L870		6063-TE
44	TO-5L863		6063-TE

STT	Mã bản vẽ	Mặt cắt sản phẩm	Hợp kim - cấp độ cứng
45	TO-5L864		6063-TE
46	TO-5L865		6063-TE
47	TO-5L866		6063-TE
48	TO-5L867		6063-TE
49	TO-5L868		6063-TE
50	TO-5L923		6063-TE
51	TO-5L924		6063-TE
52	TO-5L925		6063-TE
53	TO-5L926		6063-TE
54	TO-5L927		6063-TE
55	TO-5L928		6063-TE





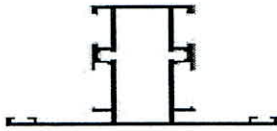
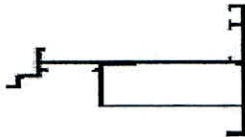
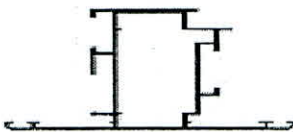
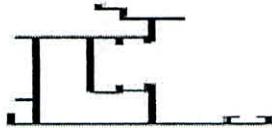
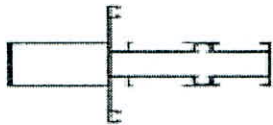
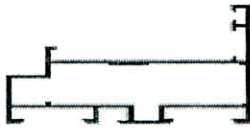
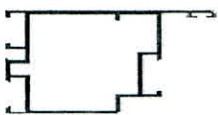
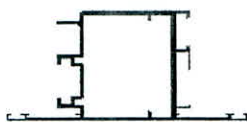
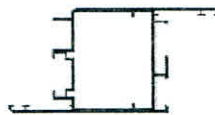
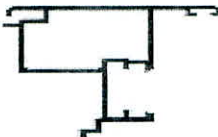





STT	Mã bản vẽ	Mặt cắt sản phẩm	Hợp kim - cấp độ cứng
56	TO-5L929		6063-TE
57	TO-5L930		6063-TE
58	TO-5L931		6063-TE
59	TO-5L932		6063-TE
60	TO-5L933		6063-TE
61	TO-5L934		6063-TE
62	TO-5L935		6063-TE
63	TO-5L936		6063-TE
64	TO-5L937		6063-TE
65	TO-5L938		6063-TE
66	TO-5H962		6063-TE

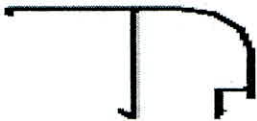





03/10/2016
 TR
 PH
 DC
 CH
 SUC





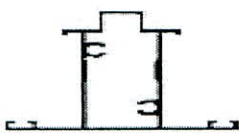

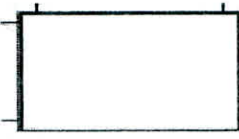
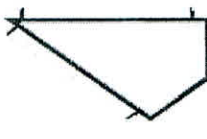
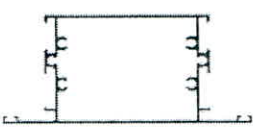
CÔNG TY TNHH T. G. G.

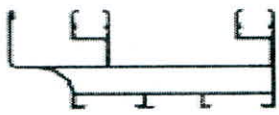
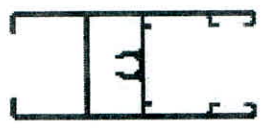
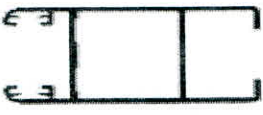

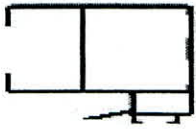
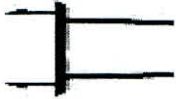

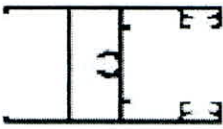
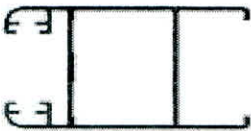

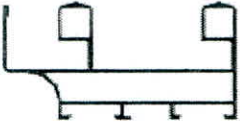
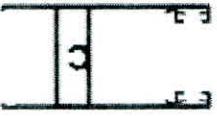
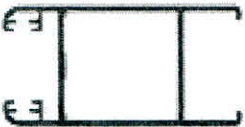
STT	Mã bản vẽ	Mặt cắt sản phẩm	Hợp kim - cấp độ cứng
67	TO-5H963		6063-TE
68	TO-5H964		6063-TE
69	TO-5H965		6063-TE
70	TO-5H967		6063-TE
71	TO-5H968		6063-TE
72	TO-5H969		6063-TE
73	TO-5H970		6063-TE
74	TO-5H971		6063-TE
75	TO-5H972		6063-TE
76	TO-5H973		6063-TE
77	TO-5H974		6063-TE

Đ. D. X. A. N. P.

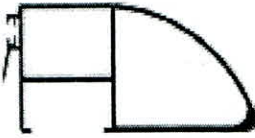

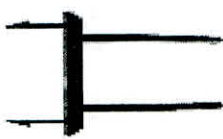
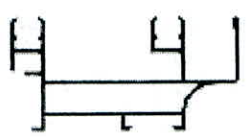

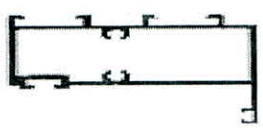

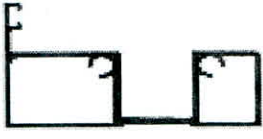
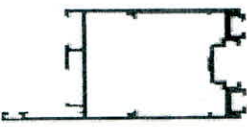
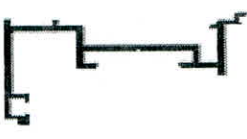
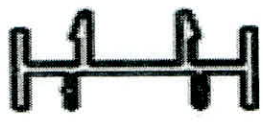



STT	Mã bản vẽ	Mặt cắt sản phẩm	Hợp kim - cấp độ cứng
78	TO-5H975		6063-TE
79	TO-5H976		6063-TE
80	TO-5H977		6063-TE
81	TO-5H978		6063-TE
82	TO-5H979		6063-TE
83	TO-5H980		6063-TE
84	TO-5H981		6063-TE
85	TO-5J143		6063-TE
86	TO-5J144		6063-TE
87	TO-5H966A		6063-TE
88	TO-5J145		6063-TE

STT	Mã bản vẽ	Mặt cắt sản phẩm	Hợp kim - cấp độ cứng
89	TO-5J146		6063-TE
90	TO-5J150		6063-TE
91	TO-5J149		6063-TE
92	TO-5J151		6063-TE
93	TO-5J152		6063-TE
94	TO-5J153		6063-TE
95	TO-5J154		6063-TE
96	TO-5J155		6063-TE
97	TO-5J156		6063-TE
98	TO-5J158		6063-TE
99	TO-5J159		6063-TE





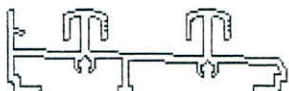

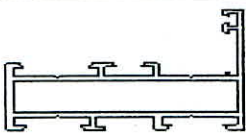
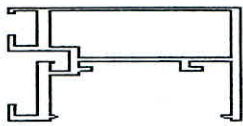

STT	Mã bản vẽ	Mặt cắt sản phẩm	Hợp kim - cấp độ cứng
100	TO-5J160		6063-TE
101	TO-5J161		6063-TE
102	TO-5J162		6063-TE
103	TO-5J164		6063-TE
104	TO-5J165		6063-TE
105	TO-5J166		6063-TE
106	TO-5J167		6063-TE
107	TO-5J168		6063-TE
108	TO-5J178A		6063-TE
109	TO-5J179		6063-TE
110	TO-5J181		6063-TE

STT	Mã bản vẽ	Mặt cắt sản phẩm	Hợp kim - cấp độ cứng
111	TO-5J182		6063-TE
112	TO-5J183		6063-TE
113	TO-5J184		6063-TE
114	TO-5J185		6063-TE
115	TO-5J212		6063-TE
116	TO-5L856		6063-TE
117	TO-5L857		6063-TE
118	TO-5L858		6063-TE
119	TO-5L859		6063-TE
120	TO-5L860		6063-TE
121	TO-5L906		6063-TE



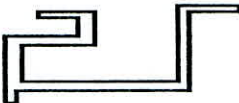
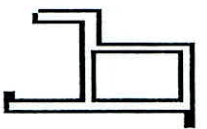

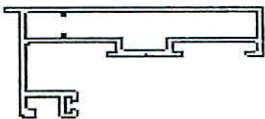





STT	Mã bản vẽ	Mặt cắt sản phẩm	Hợp kim - cấp độ cứng
122	TO-5L907		6063-TE
123	TO-5L908		6063-TE
124	TO-5L909		6063-TE
125	TO-5L910		6063-TE
126	TO-5L916		6063-TE
127	TO-5L917		6063-TE
128	TO-5L889		6063-TE
129	TO-5L919		6063-TE
130	TO-5L920		6063-TE
131	TO-5L940		6063-TE
132	TO-5L941		6063-TE

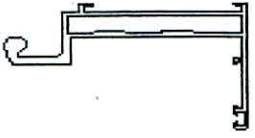

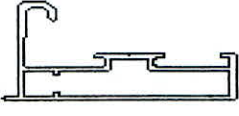

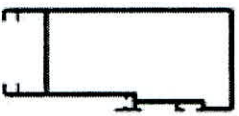
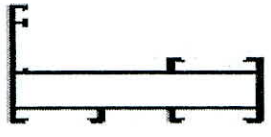
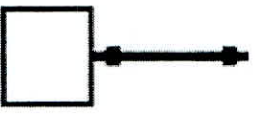
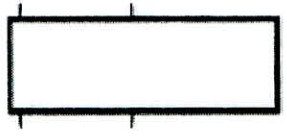

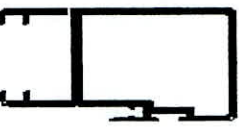

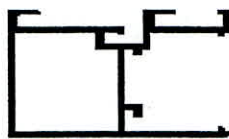

STT	Mã bản vẽ	Mặt cắt sản phẩm	Hợp kim - cấp độ cứng
133	TO-5L942		6063-TE
134	TO-5P153		6063-TE
135	TO-5P154		6063-TE
136	TO-5P155		6063-TE
137	TO-5P158		6063-TE
138	TO-5P159		6063-TE
139	TO-5P160		6063-TE
140	TO-5P161		6063-TE
141	TO-5P162		6063-TE
142	TO-5P163		6063-TE
143	TO-5P164		6063-TE





1
 2
 3
 4
 5
 6
 7
 8
 9
 10
 11
 12
 13
 14
 15
 16
 17
 18
 19
 20
 21
 22
 23
 24
 25
 26
 27
 28
 29
 30
 31
 32
 33
 34
 35
 36
 37
 38
 39
 40
 41
 42
 43
 44
 45
 46
 47
 48
 49
 50
 51
 52
 53
 54
 55
 56
 57
 58
 59
 60
 61
 62
 63
 64
 65
 66
 67
 68
 69
 70
 71
 72
 73
 74
 75
 76
 77
 78
 79
 80
 81
 82
 83
 84
 85
 86
 87
 88
 89
 90
 91
 92
 93
 94
 95
 96
 97
 98
 99
 100

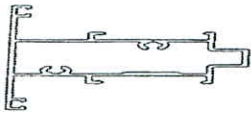
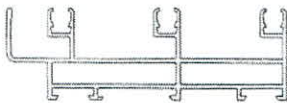

STT	Mã bản vẽ	Mặt cắt sản phẩm	Hợp kim - cấp độ cứng
144	TO-5P165		6063-TE
145	TO-5P166		6063-TE
146	TO-5P167		6063-TE
147	TO-5P168		6063-TE
148	TO-5L950		6063-TE
149	TO-5L948		6063-TE
150	TO-5L949		6063-TE
151	TO-5L876		6063-TE
152	TO-5L951		6063-TE
153	TO-5R176		6063-TE
154	TO-5R177		6063-TE

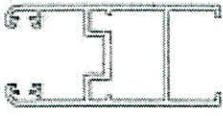

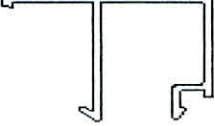
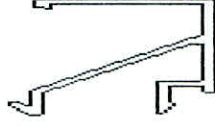
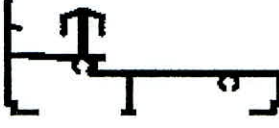
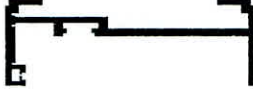
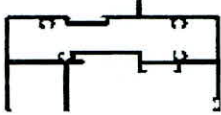
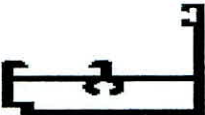
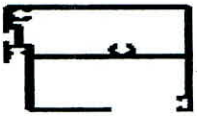





STT	Mã bản vẽ	Mặt cắt sản phẩm	Hợp kim - cấp độ cứng
155	TO-5R178		6063-TE
156	TO-5R179		6063-TE
157	TO-5R175		6063-TE
158	TO-5R180		6063-TE
159	TO-5R181		6063-TE
160	TO-5R182		6063-TE
161	TO-5R183		6063-TE
162	TO-5R184		6063-TE
163	TO-5R185		6063-TE
164	TO-5R188		6063-TE
165	TO-5R979		6063-TE

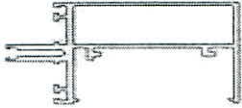

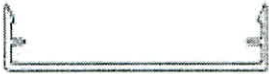
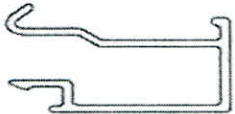
STT	Mã bản vẽ	Mặt cắt sản phẩm	Hợp kim - cấp độ cứng
166	TO-5R980		6063-TE
167	TO-5R981A		6063-TE
168	TO-5R986		6063-TE
169	TO-5S053		6063-TE
170	TO-5S054		6063-TE
171	TO-5S071		6063-TE
172	TO-5S072		6063-TE
173	TO-5S073		6063-TE
174	TO-5S074		6063-TE
175	TO-5S075		6063-TE
176	TO-5S078		6063-TE

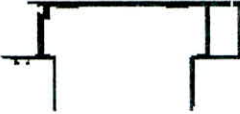

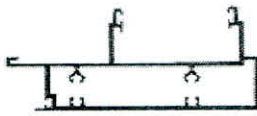





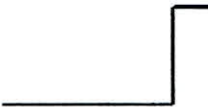

CÔNG
STAM
EU CHU
SÔNG
CUNG
100/10/1



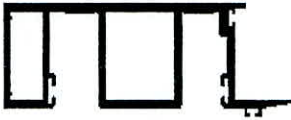

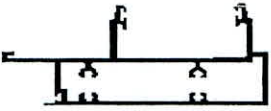
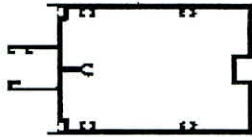

CÔNG TY TNHH



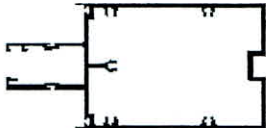
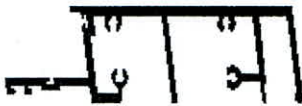
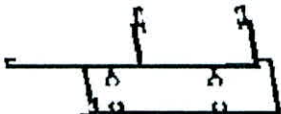

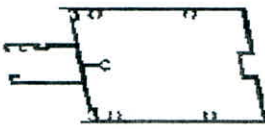
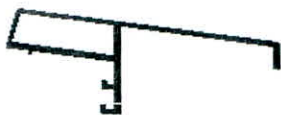





STT	Mã bản vẽ	Mặt cắt sản phẩm	Hợp kim - cấp độ cứng
177	TO-5S128		6063-TE
178	TO-5S129		6063-TE
179	TO-5S130		6063-TE
180	TO-5S131		6063-TE
181	TO-5S147		6063-TE
182	TO-5S161		6063-TE
183	TO-5P210		6063-TE
184	TO-5P211		6063-TE
185	TO-5P212		6063-TE
186	TO-5P213		6063-TE
187	TO-5P214		6063-TE

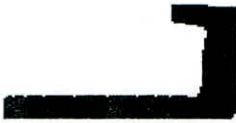

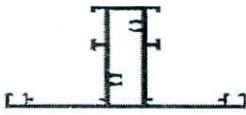

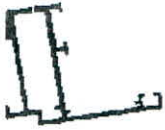



QUẢNG
 TRUNG
 CÔNG CVC

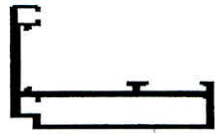

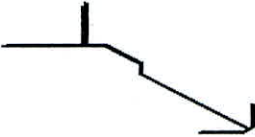
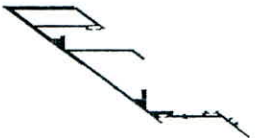
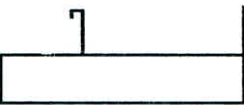



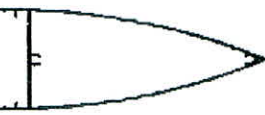

STT	Mã bản vẽ	Mặt cắt sản phẩm	Hợp kim - cấp độ cứng
188	TO-5P215		6063-TE
189	TO-5P216		6063-TE
190	TO-5P217		6063-TE
191	TO-5P218		6063-TE
192	TO-5P219		6063-TE
193	TO-5P220		6063-TE
194	TO-5P221		6063-TE
195	TO-5P222		6063-TE
196	TO-5P223		6063-TE
197	TO-5P224		6063-TE
198	TO-5P242		6063-TE

STT	Mã bản vẽ	Mặt cắt sản phẩm	Hợp kim - cấp độ cứng
199	TO-5P243		6063-TE
200	TO-5P244		6063-TE
201	TO-5P225		6063-TE
202	TO-5P226		6063-TE
203	TO-5P227		6063-TE
204	TO-5P228		6063-TE
205	TO-5P229		6063-TE
206	TO-5P230		6063-TE
207	TO-5P231		6063-TE
208	TO-5P232		6063-TE
209	TO-5P233		6063-TE

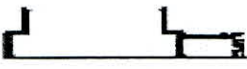
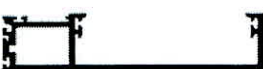
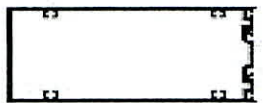

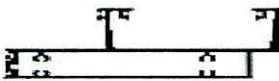
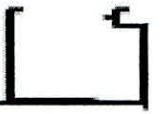





STT	Mã bản vẽ	Mặt cắt sản phẩm	Hợp kim - cấp độ cứng
210	TO-5P234		6063-TE
211	TO-5P245		6063-TF
212	TO-5P246		6063-TF
213	TO-5P249		6063-TE
214	TO-5P250		6063-TE
215	TO-5R114		6063-TE
216	TO-5R115		6063-TE
217	TO-5R116		6063-TE
218	TO-5R117		6063-TE
219	TO-5R118		6063-TE
220	TO-5P247		6063-TF

STT	Mã bản vẽ	Mặt cắt sản phẩm	Hợp kim - cấp độ cứng
221	TO-5P248		6063-TE
222	TO-5R119		6063-TE
223	TO-5R120		6063-TE
224	TO-5R121		6063-TE
225	TO-5R122		6063-TE
226	TO-5R123		6063-TE
227	TO-5R124		6063-TE
228	TO-5R125		6063-TE
229	TO-5R126		6063-TE
230	TO-5R127		6063-TE
231	TO-5R128		6063-TE

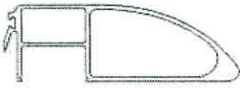



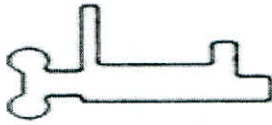
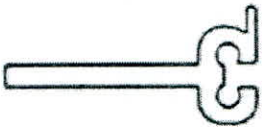



HQC
TRUI
THUA
DO
HA
CHU

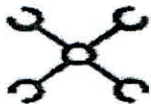





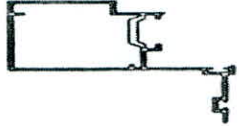
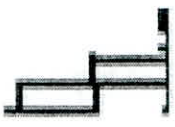
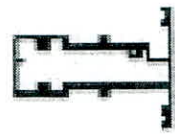

STT	Mã bản vẽ	Mặt cắt sản phẩm	Hợp kim - cấp độ cứng
232	TO-5R129A		6063-TE
233	TO-5S010		6063-TE
234	TO-5S011		6063-TE
235	TO-5S012		6063-TE
236	TO-5S013		6063-TE
237	TO-5S014		6063-TE
238	TO-5S015		6063-TE
239	TO-5S016		6063-TE
240	TO-5S017		6063-TE
241	TO-5S018		6063-TE
242	TO-5S019		6061-TF

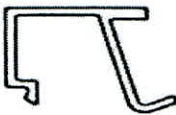

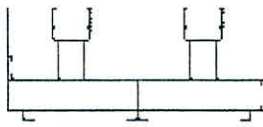
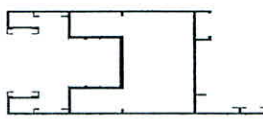
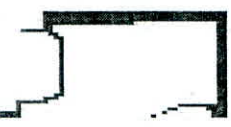

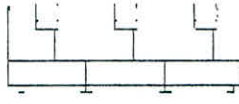



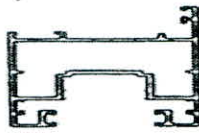

STT	Mã bản vẽ	Mặt cắt sản phẩm	Hợp kim - cấp độ cứng
243	TO-5S020		6061-TF
244	TO-5S021		6061-TF
245	TO-5S022		6061-TF
246	TO-5L903		6063-TE
247	TO-5L905		6063-TE
248	TO-5L904		6063-TE
249	TO-5L882		6063-TE
250	TO-5S092		6063-TF
251	TO-5S093		6063-TF
252	TO-5S094		6063-TF
253	TO-5S095		6063-TF





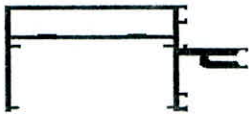

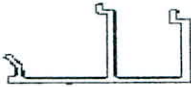
3/2
 AN PHU
 AN PHU

STT	Mã bản vẽ	Mặt cắt sản phẩm	Hợp kim - cấp độ cứng
254	TO-5S096A		6063-TF
255	TO-5S157		6063-TE
256	TO-5S158		6063-TE
257	TO-5S159		6063-TE
258	TO-5S160		6063-TE
259	TO-5S098		6063-TE
260	TO-5S018		6063-TE
261	TO-5X293		6063-TE
262	TO-5X294		6063-TE
263	TO-5X295		6063-TE
264	TO-5X296		6063-TE

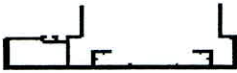
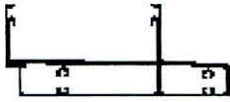
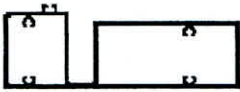
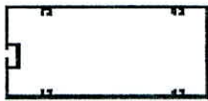
STT	Mã bản vẽ	Mặt cắt sản phẩm	Hợp kim - cấp độ cứng
265	TO-5X297		6063-TE
266	TO-5X323		6063-TE
267	TO-5X324		6063-TE
268	TO-5X325		6063-TE
269	TO-5X326		6063-TE
270	TO-5X327		6063-TE
271	TO-5X345		6063-TE
272	TO-5X355		6063-TE
273	TO-5X356		6063-TE
274	TO-5X382		6063-TE
275	TO-5X383		6063-TE



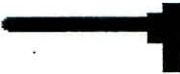



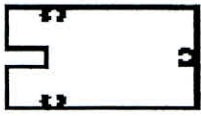

CÔNG NGHỆ
 CHUẨN
 NG
 HNG 3
 10/04

STT	Mã bản vẽ	Mặt cắt sản phẩm	Hợp kim - cấp độ cứng
276	TO-5X346A		6063-TE
277	TO-5X347A		6063-TE
278	TO-5X348A		6063-TE
279	TO-5X349A		6063-TE
280	TO-5X350		6063-TE
281	TO-5X351		6063-TE
282	TO-5X353A		6063-TE
283	TO-5X352		6063-TE
284	TO-5X431		6063-TE
285	TO-5X432		6063-TE
286	TO-5X423		6063-TE



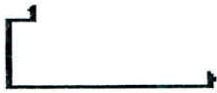
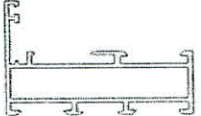
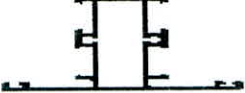

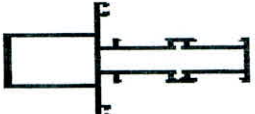

STT	Mã bản vẽ	Mặt cắt sản phẩm	Hợp kim - cấp độ cứng
287	TO-5W974		6063-TE
288	TO-5W975		6063-TE
289	TO-5W976		6063-TE
290	TO-5W977		6063-TE
291	TO-5W978		6063-TE
292	TO-5W979		6063-TE
293	TO-5W983		6063-TE
294	TO-5W984		6063-TE
295	TO-5W985		6063-TE
296	TO-5W986		6063-TE
297	TO-5W987		6063-TE

HOA W
TR
KỸ THU
Đ
C
H
H

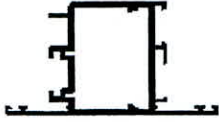
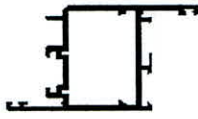
1-10/2024

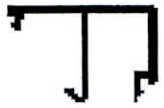

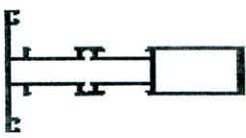
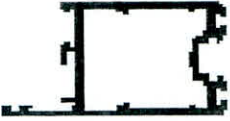

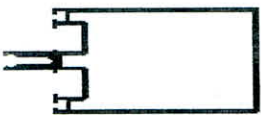

STT	Mã bản vẽ	Mặt cắt sản phẩm	Hợp kim - cấp độ cứng
298	TO-5W988		6063-TE
299	TO-5W992		6063-TE
300	TO-5W993		6063-TE
301	TO-5X298		6063-TE
302	TO-5S161A		6063-TE
303	TO-5X302		6063-TE
304	TO-5X303		6063-TE
305	TO-5X304		6063-TE
306	TO-5X305		6063-TE
307	TO-5X306		6063-TE
308	TO-5X307		6063-TE

AC
ST
EU
UC
UK
10

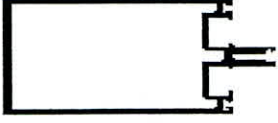
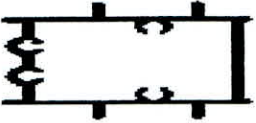
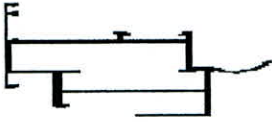
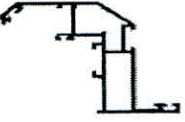
STT	Mã bản vẽ	Mặt cắt sản phẩm	Hợp kim - cấp độ cứng
309	TO-5X308		6063-TE
310	TO-5X309		6063-TE
311	TO-5X310		6063-TE
312	TO-5X311		6063-TE
313	TO-5X312		6063-TE
314	TO-5X313		6063-TE
315	TO-5X314		6063-TE
316	TO-5X315		6063-TE
317	TO-5X316		6063-TE
318	TO-5X317		6063-TE
319	TO-5X328		6063-TE

NGHE
AN
C
C

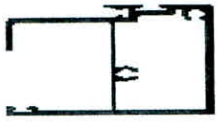
HANH L. ĐO
C

STT	Mã bản vẽ	Mặt cắt sản phẩm	Hợp kim - cấp độ cứng
320	TO-5X329		6063-TE
321	TO-5X330		6063-TE
322	TO-5X331		6063-TE
323	TO-5X332		6063-TE
324	TO-5X333		6063-TE
325	TO-5X335		6063-TE
326	TO-5X336		6063-TE
327	TO-5X337		6063-TE
328	TO-5X388		6063-TE
329	TO-5X482		6063-TE